

## Alkaline Manganese Dry Battery AM3/LR6

### 1. Scope

This specification is applicable to the “Vinnic” brand Alkaline Manganese Mercury Free Dry Batteries supplied by CHUNG PAK BATTERY WORKS, LTD.

### 2. Technical Specification

2.1 Name (Designation) : AM3 (Mercury free)

(IEC Designation) : LR6

2.2 Dimensions:

Diameter : 14.5mm

Height : 50.5mm

2.3 Weight (approx) : 23.5g

2.4 Nominal voltage : 1.5V

2.5 Typical capacity : 2700mAh at 43Ω 4h/day, E.V.0.9V (The average discharging time of 9pcs batteries)

2.6 Typical duration : 420min at 3.9Ω 1h/day, E.V.0.8V (The average discharging time of 9pcs batteries)

95 hrs at 43Ω 4h/day, E.V.0.9V (The average discharging time of 9pcs batteries)

2.7 Retention : 93% after 12 months storage(20℃)

88% after 24 months storage(20℃)

85% after 36 months storage(20℃)

80% after 60 months storage(20℃)

2.8 The Drawing of The Finished Battery :

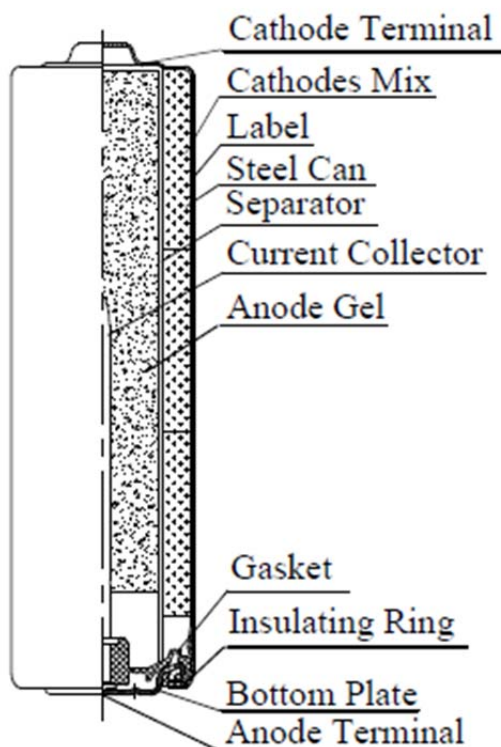

## Alkaline Manganese Dry Battery AM3/LR6

### 2.9 Outside shape dimensions and terminals:

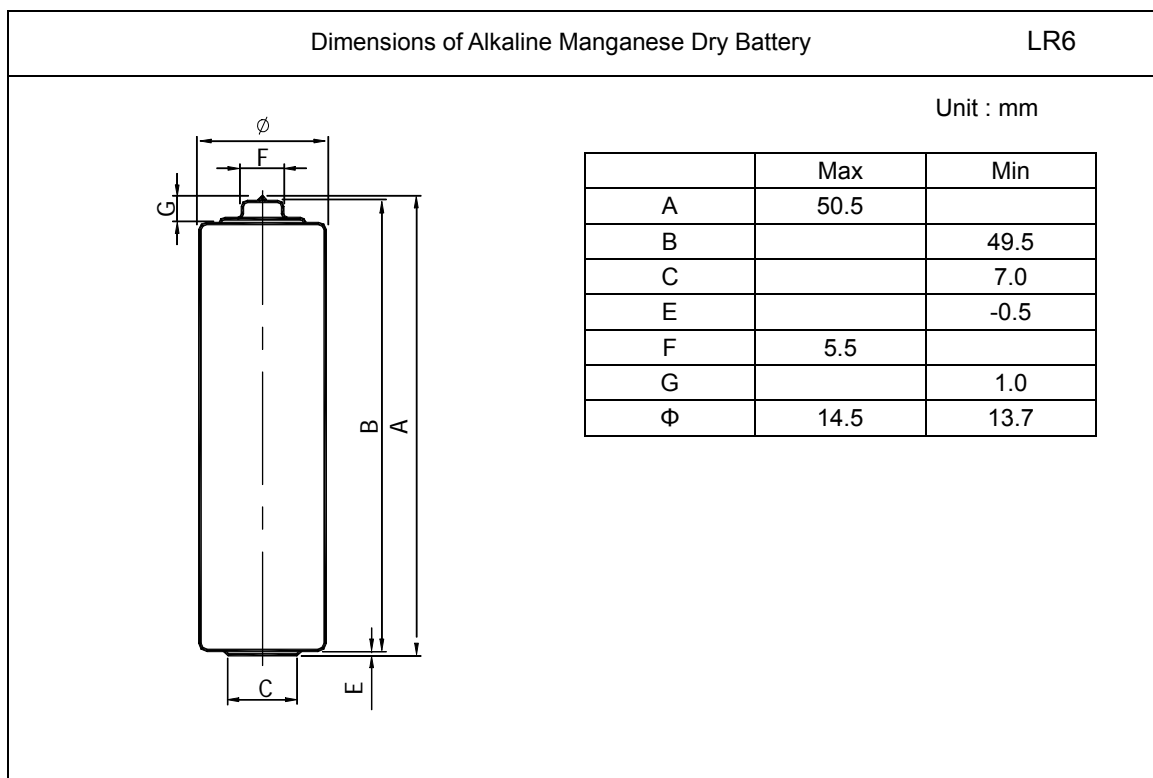

Remarks :

A: Overall height of battery

B: Height between contact terminals without pip

C: Outer diameter of negative terminal Contact area

E: Negative terminal protrusion

F: Diameter of positive terminal within The specified projection height

G: Height of projected area of positive terminal, exclusive part

Ø: Diameter of battery

## Alkaline Manganese Dry Battery AM3/LR6

### 3. Performance (For all test method, refer to Appendix 1)

#### 3.1 Open-circuit Voltage

Storage Time	OCV (V) Open-circuit Voltage
Initial	1.600 ~ 1.680 V
After 12 months storage	1.550 ~ 1.660 V
After 24 months storage	1.530 ~ 1.650 V
After 36 months storage	1.520 ~ 1.630 V
After 60 months storage	1.510 ~ 1.600 V

#### 3.2 Discharge Performance

(20±2 °C ,RH60±20% , load resistance include all external circuit,error within ±0.5%):

Reference Requirement	Discharge Condition			Average Minimum duration				
	Load resistance	Discharge method	End point Voltage(V)	Initial	After 12 months storage	After 24 months storage	After 36 months storage	After 60 months storage
IEC	3.9Ω	*	0.90 V	395 min	367 min	347 min	335 min	316 min
IEC	3.9Ω	1h /day	0.80 V	415 min	385 min	365 min	352 min	332 min
REF	3.9Ω	24h/day	0.90 V	375 min	348 min	330 min	318 min	300 min
IEC	43Ω	4h /day	0.90 V	85 hrs	79 hrs	74.8 hrs	72.2 hrs	68 hrs
IEC	50mA	**	1.00V	43 hrs	40 hrs	37.8 hrs	36.5 hrs	34.4 hrs
IEC	100mA	1h /day	0.90V	20 hrs	18.6 hrs	17.6 hrs	17 hrs	16 hrs
IEC	250mA	1h /day	0.90 V	7.6 hrs	6.7 hrs	6.3 hrs	6.1 hrs	5.8 hrs
IEC	1500/650mW	***	1.05 V	70 times	65 times	61 times	59 times	56 times

“\*\*” : 4min on, 56min off for 8h per day;

“\*\*\*” : 1h on, 7h off for 24h per day;

“\*\*\*\*” : Repeat 10 times per hour: 1 500 mW for 2 s, then 650 mW for 28 s, then 0 mW for 55 min.

The word“initial”is applicable to the products elapsed one month or less after production , including those , to which tests have been started in less than three month after production.

## Alkaline Manganese Dry Battery AM3/LR6

Satisfaction Standard:

- 1) 9 piece of battery will be tested for each discharging standard;
- 2) The result of the average discharging time from each discharging standard shall be equal to or more than the average minimum time requirement; and no more than one battery has a service output less than 80% of the specified requirement.
- 3) One re-test is allowed to confirm the previous result.

### 3.3 Overdischarge electrolyte leakage resistance:

No deformation and no external electrolyte leakage shall be observed.

### 3.4 High temperature electrolyte leakage resistance:

No deformation and no external electrolyte leakage shall be observed.

3.5 Expiry date : 5 years after manufactured.

### 3.6 Safety Test

#### 3.6.1 Intended use tests and requirements (appendx : 1)

Test		Intended use simulation	Requirements
Electrical test A		Storage after partial use	No leakage (NL) No explosion (NE)
Environmental Tests	B-1	Transportation shock	No leakage (NL) No explosion (NE)
	B-2	Transportation vlbation	No leakage (NL) No explosion (NE)
Climatic-temperature C		Climatic-temperature cycling	No explosion (NE)

#### 3.6.2 Reasonably foreseeable misuse tests and requirements

Test		Misuse simulation	Requirements
Electrical tests	D	Incorrect installation	No explosion (NE)
	E	External short circuit	No explosion (NE)
	F	overdischarge	No explosion (NE)
Environmental test G		Free fall	No explosion (NE)

**All of test (3.6) are meet IEC 60086-5 & GB 8897.5-2013.**

## 4. Content of heavy metals (meet IEC 2006/66/EC)

The following material content of heavy metals in the batteries:

Hg	Cd	Pb
<0.0001%	<0.002%	<0.004%

## Alkaline Manganese Dry Battery AM3/LR6

### 5. Brand and packaging

#### 5.1 Appendix 1:Standard and packaging



AM3/LR6 – SP4

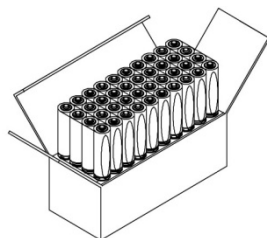

40 Per Display Boxes  
Boxes Measure : 142X55X52 mm

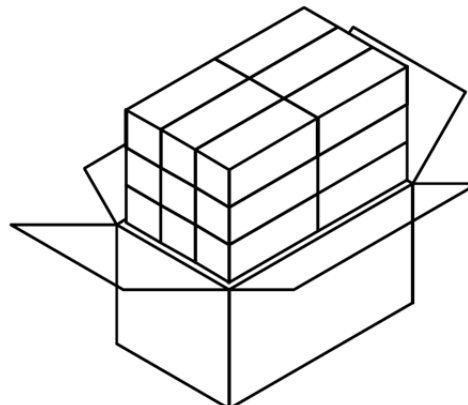

720 PCS Per Display Carton  
Carton Measure : 293X180X165mm

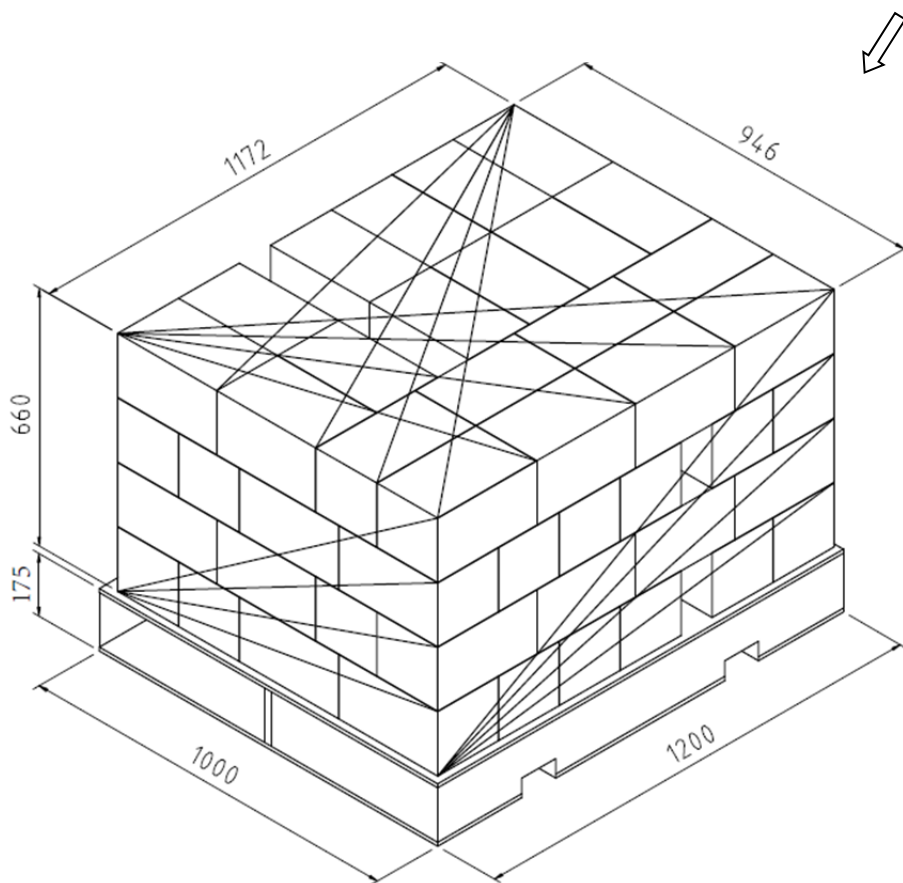

Goods Dimension  
Height : 660mm  
Length : 1172mm  
Width : 946mm

Plastic Pallet:  
Pallet Height : 175mm  
Pallet Measure : 1200X1000mm

Weight  
Pallet Weight : 22kg  
Net Weight : 1366 kg  
Gross Weight With Pallet : 1419 kg

Quantity :  
1 Layer = 20 Cartons  
4 Layers X 20 Cartons= 80 Cartons / Pallet

5.2 Both OEM and ODM orders are welcome. Any specific design and packaging requirements will be accommodated as required.

## Alkaline Manganese Dry Battery AM3/LR6

### 6. Safety instructions

Warning	Danger
① Don't throw the batteries into fire or heat the batteries.	This may cause the batteries to disrupt or ignite.
② Don't directly solder the batteries.	This may damage their insulating tapes and protective installation.
③ Don't insert and use batteries with the  &  electrode inverse.	This can damage the batteries for being force charged, even may cause leakage, heat generation , disrupt, explosion or ignition.
④ Don't short-circuit the positive and negative terminals of a battery.	This may cause heat generation, leakage, explosion, fire and personal injury.
⑤ Don't expose the batteries to water.	This can cause heat generation or rust.
⑥ Don't charge and force discharge batteries.	This may cause leakage, heat generation, even explosion and ignition.
⑦ Don't disassemble or damage the external tubes of the batteries or modify the batteries(stack-up batteries) etc.	This easily results in short-circuit, leakage, even ignition.
⑧ Store unused batteries in their original packaging away from metal objects.	This can cause battery short-circuiting which may result in venting, leakage, and explosion and personal injury.
⑨ Don't crush, puncture, or otherwise mutilate to deform batteries.	This may cause venting, leakage, explosion and personal injury.
⑩ Immediately stop using the batteries if leakage, discolor or etc. with them are detected.	This may cause accidents to occur.
⑪ Don't drop or strongly strike the batteries.	This may result in leakage, heat generation, disrupt, even ignition.
⑫ To avoid using at high temperature and high /humidity ambient.	This may cause batteries early damage.
⑬ a. Be sure to use the batteries within a temperature range from 0℃ to 40℃.  b. Be sure to storage the batteries within a temperature range at 20±5℃.	a. Use the batteries beyond the temperature range may cause leakage, heat generation, impaired performance, and shortening of service life of the batteries. b. Storage the batteries beyond the temperature range may cause heat generation, impaired performance, and shortening of service life of the batteries.
⑭ Don't use old batteries with new ones.	Some batteries may be over-discharged. This can result in venting, leakage, explosion and personal injury.
⑮ Don't use our batteries with any other type or brand of batteries.	Mixed-matching of batteries may result in heat generation, leakage or explosion.
⑯ Remove batteries from equipment if it is not to be used for an extended period of time.	When batteries beyond expiry period, electrolyte leakage may occur causing damage to the equipment.
⑰ Exhausted batteries should be immediately removed from equipment.	When discharged batteries are kept in the equipment for a long time, electrolyte leakage may occur causing damage to the appliance and/or personal injury.
⑱ Keep the batteries out of the reach of children.	To avoid being swallowed. If swallowed, Please see doctor immediately.
⑲ Don't allow children to replace batteries without adult supervision.	This may cause wrong operation, even may occur accident.
⑳ Please use batteries within expiry period.	When batteries beyond expiry period, electrolyte leakage may occur causing damage to the equipment. And may impair batteries performance.
㉑ Don't take batteries by hand directly. Please wear finger cots.	This may cause rust.
㉒ Don't take batteries with iron tweezer. Please use plastic tweezer.	This can cause battery short-circuiting which may result in heat generation , leakage, and explosion.

## Alkaline Manganese Dry Battery AM3/LR6

### Appendix 1: Test

#### 1. Storage and test conditions for samples

Unless otherwise specified, the storage and test conditions for samples shall be , as a general rule , at the temperature of  $20\pm 2^{\circ}\text{C}$  and the humidity of  $55\pm 20\%$ .

#### 2. Measuring instruments and devices

2.1 Voltmeter : The accuracy of the measuring equipment shall be  $\leq 0.25\%$  and the precision shall be  $\leq 50\%$  of the value of the last significant digit. The internal resistance of the measuring instrument shall be  $\geq 1\text{M}\Omega$ .

2.2 Load resistance : The load resistance shall include all of the external circuit, and its allowance shall be within  $\pm 0.5\%$ .

2.3 Caliper : The caliper shall be the one having precision of 0.05 millimeters or the one having the same or superior precision to this.

#### 3. Test method

3.1 Dimensions : Measurements shall be made by use of the calipers.

3.2 Appearance : Examination shall be carried out by visual inspection.

3.3 Open-circuit voltage: Measurements shall be carried out before the start of discharge of the sample by use of the voltmeter.

#### 3.4 Service output

Discharge start time: After leaving in an atmosphere at a temperature of  $20\pm 2^{\circ}\text{C}$  for at least 8 hours or more.

Discharge temperature and humidity:  $20\pm 2^{\circ}\text{C}$ ,  $55\pm 20\%$ .

Discharge method : As defined in 3.2. However discharge shall be effected for more than 5 days during 7 days and when discharge is made twice a day, an interval of 4 hours shall be elapsed between two discharges.

Discharge end-point : The instant when the closed-circuit voltage has reached below the end-point voltage (as defined in 3.2, Page 3).

## Alkaline Manganese Dry Battery AM3/LR6

### 3.5 Overdischarge electrolyte leakage resistance

The following conditions shall be adopted for the test.

- (a) Discharge start point: After keeping at the temperature of  $20\pm 2^\circ\text{C}$  for at least 8 hours or more
- (b) Test temperature and humidity:  $20\pm 2^\circ\text{C}$ ,  $55\pm 20\%$
- (c) Load resistance :  $5\Omega$
- (d) Test method : Continuous discharge for 48 hours .

### 3.6 High temperature electrolyte leakage resistance

The following conditions shall be adopted for the test

- (a) Test temperature and humidity:  $45\pm 2^\circ\text{C}$ , below 70% RH.
- (b) Test period : 30 days
- (c) Test method : Leave to stand still.

## Appendix 2 : Discharge characteristics

### STANDARD DISCHARGE CURVE:

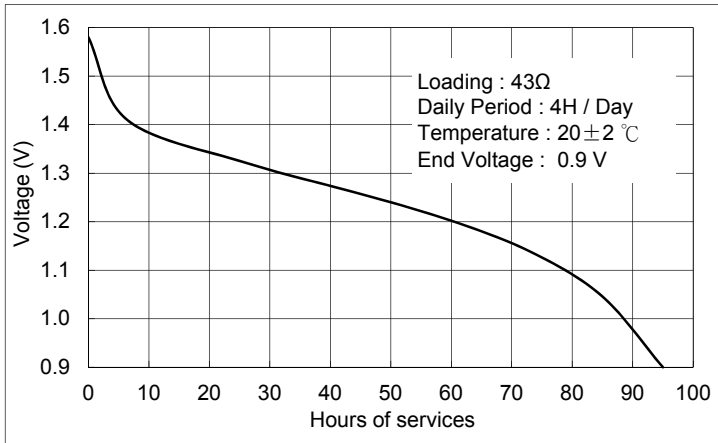
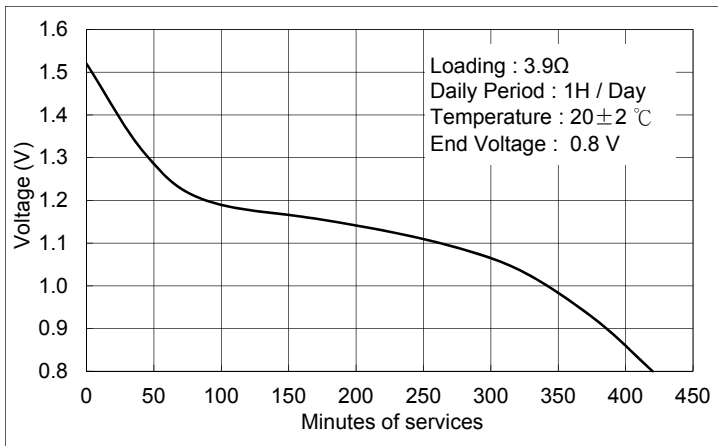

### TEMPERATURE CHARACTERISTICS: (Discharge continuously at various resistance)

