

## Silver Oxide Button Cell 364F

### 1 · Scope

The specification is applicable to the “Vinnic” brand Silver Oxide Button Cell 364F (Mercury free) supplied by CHUNG PAK BATTERY WORKS LTD.

### 2 · Kind of Products Specified

Name (Designation) : 364F

IEC Designation : SR60

### 3 · Technical Specification

3.1 Dimension :

Height (H)	2.15	$\begin{matrix} +0 \\ -0.25 \end{matrix}$	mm
Diameter (Φ)	6.8	$\begin{matrix} +0 \\ -0.25 \end{matrix}$	mm

3.2 Average Weight : 0.27 g

3.3 Nominal Voltage : 1.55 V

3.4 Nominal Capacity : 9.0 mAh (Discharge at 6.5KΩ to 0.9V )

3.5 Typical Discharge Duration: 45 hrs (Discharge at 6.5KΩ to 0.9V )

400 hrs (Discharge at 68KΩ to 1.2V )

3.6 The Drawing of the Finished Battery :

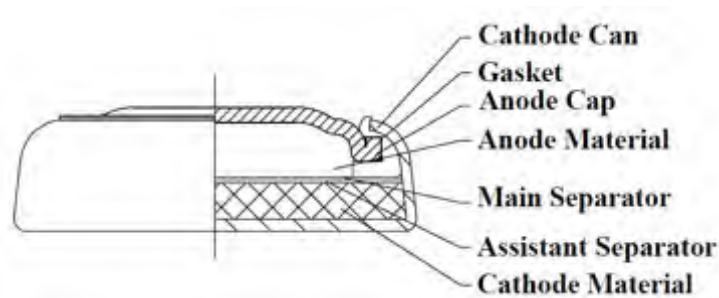

Remark: There is deviation between part shape of “The Finished Battery Drawing” and actual product.

The Drawing of Finished Battery is for reference only.

## Silver Oxide Button Cell 364F

### 3.7 Outside Shape Dimensions and Terminals :

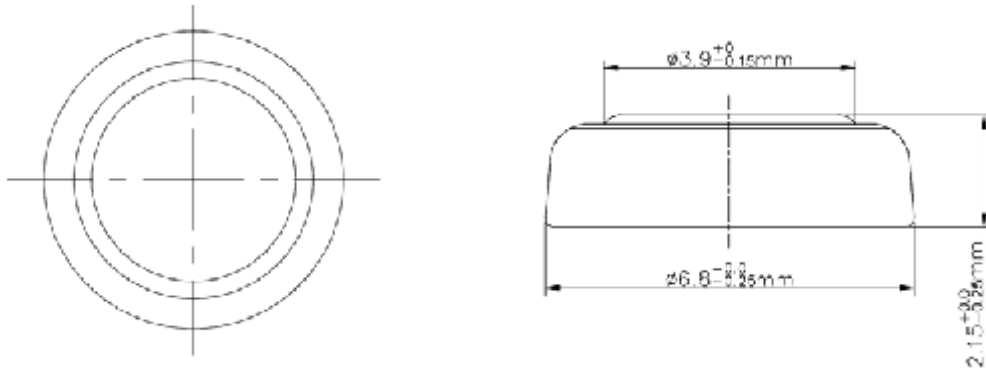

## 4 Performance

### 4.1 Open-circuit Voltage :

Initial	1.55 – 1.63 V
After 12 Months Storage	1.55 – 1.63 V

### 4.2 Service Out-put :

Load Resistance	6.5 K $\Omega$	68 K $\Omega$
Discharge Method	Continuously	Continuously
End-point Voltage	0.9 V	1.2 V
Minimum Duration (Initial)	41 Hrs	360 Hrs
Minimum Duration (After 12 Months Storage)	37 Hrs	325 Hrs

Remark : The word "initial" is applicable to the products elapsed three months or less after production.

### 4.3: High Temperature Electrolyte Leakage Resistance :

No deformation and no external electrolyte leakage shall be observed.

### 4.4 Expiry period : One year .

## Silver Oxide Button Cell 364F

### 5 · Brand and packaging

#### 5.1 Appendix 1: Standard and Packaging

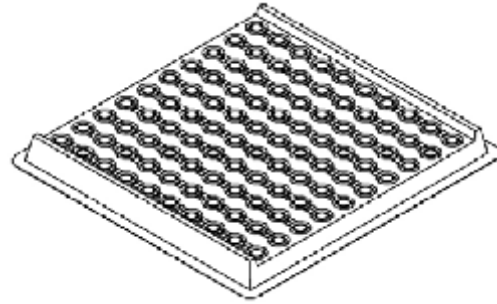

Silver oxide Button Cell 364F

100PCS Per Display Pallet

White Insulating Pallet Measure : 130X123.5X11 mm

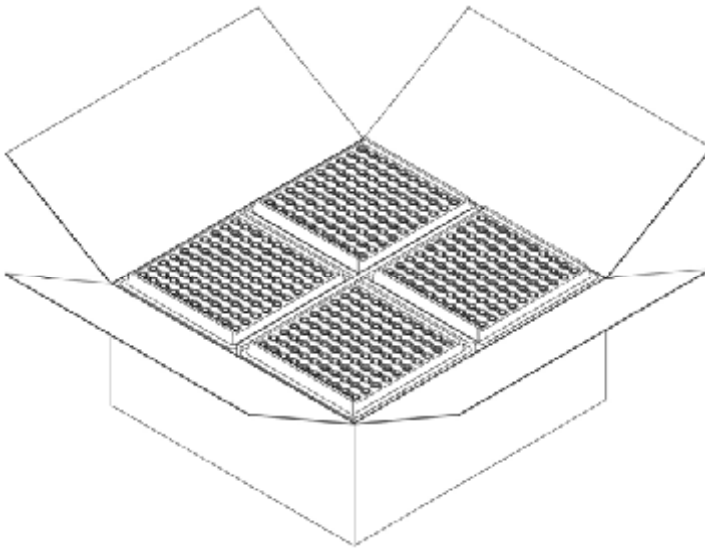

16000 PCS Per Display Carton

Carton Measure : 270X260X118 mm

5.2 Any specific design and packing requirements will be accommodated as required.

## Silver Oxide Button Cell 364F

### 6 · Safety instructions

Warning	Danger
① Don't throw the batteries into fire or heat the batteries.	This may cause the batteries to disrupt or ignite.
② Don't directly solder the batteries.	This may damage their insulating tapes and protective installation.
③ Don't insert and use batteries with the  &  electrode inverse.	This can damage the batteries for being force charged, even may cause leakage, heat generation , disrupt, explosion or ignition.
④ Don't short-circuit the positive and negative terminals of a battery.	This may cause heat generation, leakage, explosion, fire and personal injury.
⑤ Don't expose the batteries to water.	This can cause heat generation or rust.
⑥ Don't charge and force discharge batteries.	This may cause leakage, heat generation, even explosion and ignition.
⑦ Don't disassemble or damage the external tubes of the batteries or modify the batteries(stack-up batteries) etc.	This easily results in short-circuit, leakage, even ignition.
⑧ Store unused batteries in their original packaging away from metal objects.	This can cause battery short-circuiting which may result in venting, leakage, and explosion and personal injury.
⑨ Don't crush, puncture, or otherwise mutilate to deform batteries.	This may cause venting, leakage, explosion and personal injury.
⑩ Immediately stop using the batteries if leakage, discolor or etc. with them are detected.	This may cause accidents to occur.
⑪ Don't drop or strongly strike the batteries.	This may result in leakage, heat generation, disrupt, even ignition.
⑫ To avoid using at high temperature and high humidity ambient.	This may cause batteries early damage.
⑬ a. Be sure to use the batteries within a temperature range from 0℃ to 40℃.  b. Be sure to storage the batteries within a temperature range at 20±5℃.	a. Use the batteries beyond the temperature range may cause leakage, heat generation, impaired performance, and shortening of service life of the batteries.  b. Storage the batteries beyond the temperature range may cause heat generation, impaired performance, and shortening of service life of the batteries.
⑭ Don't use old batteries with new ones.	Some batteries may be over-discharged. This can result in venting, leakage, explosion and personal injury.
⑮ Don't use our batteries with any other type or brand of batteries.	Mixed-matching of batteries may result in heat generation, leakage or explosion.
⑯ Remove batteries from equipment if it is not to be used for an extended period of time.	When batteries beyond expiry period, electrolyte leakage may occur causing damage to the equipment.
⑰ Exhausted batteries should be immediately removed from equipment.	When discharged batteries are kept in the equipment for a long time, electrolyte leakage may occur causing damage to the appliance and/or personal injury.
⑱ Keep the batteries out of the reach of children.	To avoid being swallowed. If swallowed, Please see doctor immediately.
⑲ Don't allow children to replace batteries without adult supervision.	This may cause wrong operation, even may occur accident.
⑳ Please use batteries within expiry period.	When batteries beyond expiry period, electrolyte leakage may occur causing damage to the equipment. And may impair batteries performance.
㉑ Don't take batteries by hand directly. Please wear finger cots.	This may cause rust.
㉒ Don't take batteries with iron tweezer. Please use plastic tweezer.	This can cause battery short-circuiting which may result in heat generation , leakage, and explosion.

## Silver Oxide Button Cell 364F

### Appendix 1 : Test

#### 1. Storage and Test Conditions for Samples

Unless otherwise specified, the storage conditions for samples shall be, as a general rule, at the temperature of  $20\pm 2^{\circ}\text{C}$  and the humidity of  $55\pm 20\%$ .

#### 2. Measuring Instruments

2.1 Voltmeter : The accuracy of the measuring equipment shall be  $\leq 0.25\%$  and the precision shall be  $\leq 50\%$  of the value of the last significant digit. The internal resistance of the measuring instrument shall be  $\geq 1\text{M}\Omega$ .

2.2 Load Resistance: The load resistance shall include all of the external circuit, and its allowance shall be within  $\pm 0.5\%$ .

2.3 Caliper : The caliper shall be the one having precision of 0.02 millimeters or the one having the same or superior precision to this.

#### 3. Test Method

3.1 Dimensions : Measurements shall be made by use of the calipers.

3.2 Appearance : Examination shall be carried out by visual inspection .

3.3 Open-circuit Voltage : Measurements shall be carried out before the start of discharge of the sample by use of the voltmeter .

3.4 Service Out-put :

Discharge Start Time : After leaving in an atmosphere at a temperature of  $20\pm 2^{\circ}\text{C}$  for at least 8 hours or more .

Discharge Method : As defined in 4.2 , page 2 .

Discharge End-point : The instant when the closed-circuit voltage has reached below the end-point voltage(as defined in 4.2, page 2).

3.5 High Temperature Electrolyte Leakage Resistance

The following conditions shall be adopted for the test :

- (1) Test temperature and humidity :  $45\pm 2^{\circ}\text{C}$ , below 70%RH .
- (2) Test period : Leave to stand still 30 days .

## Silver Oxide Button Cell 364F

### Appendix 2 : Discharge Characteristics

Standard Discharge Curve :

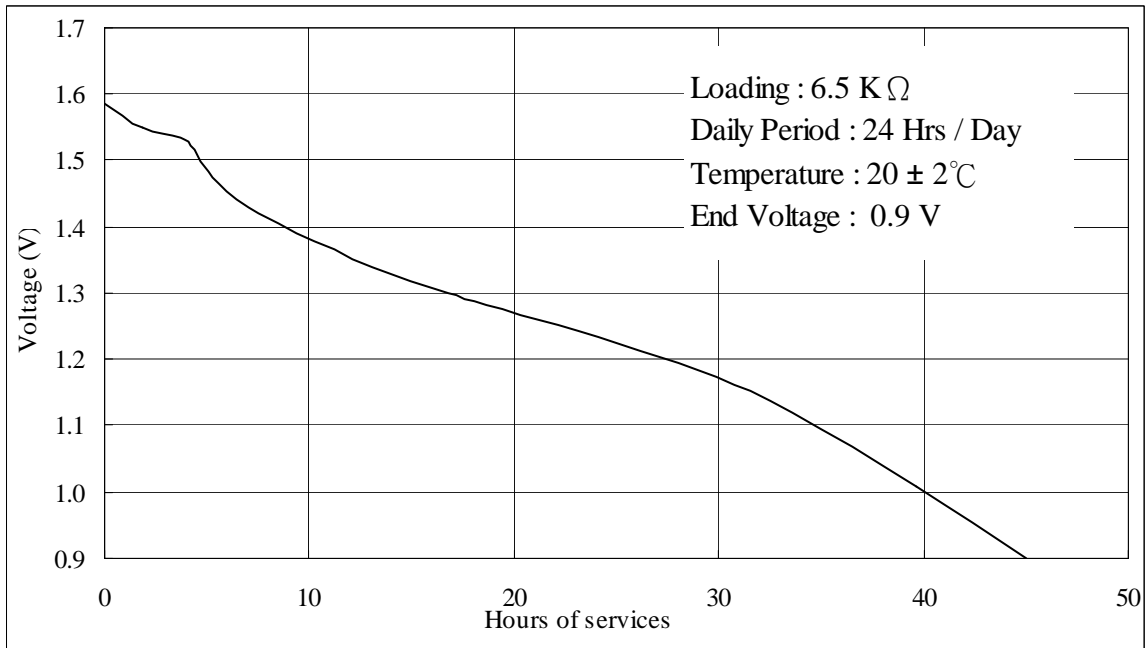
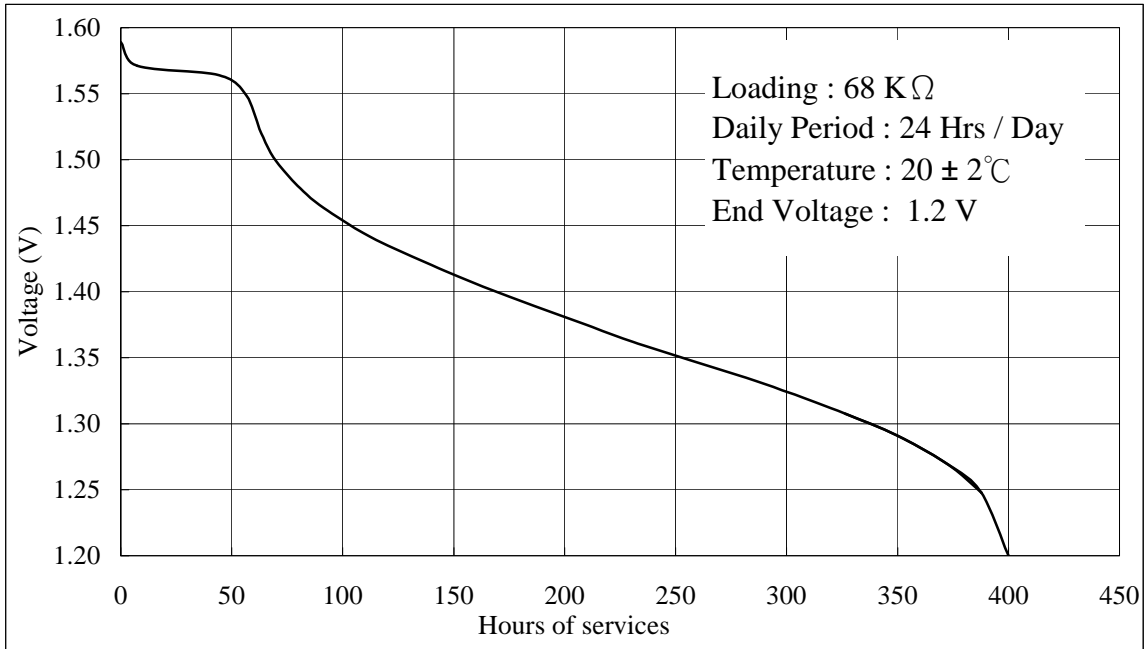

## Silver Oxide Button Cell 364F

Temperature Characteristic :

